

DESCRIPTION OF PARTS

LED wall luminaire swivelling, set of instructions for assembly, operation and safety, luminaire housing: Aluminum die-cast
Housing colors: white, black | Decoration rings: white, black, gold

TECHNICAL DATA

220-240V, 50 Hz
Connected load:
Direct (single): **8W**
Direct/indirect (double), dimmable R.C: **16W**
Beam angle: 40°
Colour temperature: 2700K

Dimensions:

Leuchte direkt: Luminaire total height: H165 mm
Luminaire head Ø108xH65 mm, Wall mounting base Ø81 mm
Swivel range: X axis 330°

Leuchte direct/indirect with lens

Luminaire head Ø108xH110 mm, Wall mounting base Ø100 mm
Swivel range: X axis 330°

Installation: Indoors
Protection class: I
Degree of protection: IP20

The light source is only exchangeable by a professional.

The product consists of two components. Luminaire with light source and external LED Driver.

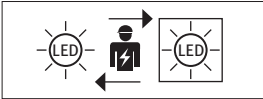

The light source is only exchangeable by a professional.

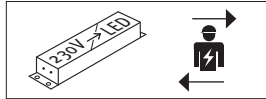

The LED driver is only exchangeable by a professional.



Protection class I



Notification of Risks



CE label



Safety Instructions



The product is only for use in interiors.



Cleaning Instructions



The product may not be disposed of in the household garbage.



LED luminaire gets very warm during operation. Be careful when touching the body.



Don't look directly into the LED! The LED is that bright that it might damage your eyes!



Dimmable TRIAC

DISPOSAL

The packaging consists of environmentally friendly materials. Dispose of them in the local recycling containers.



Do not dispose of this product in the household garbage when it has reached the end of its lifecycle, but rather take it to a disposal center. Your local officials will provide you with information about collection offices and their business hours.

SAFETY



READ THE INSTRUCTIONS BEFORE USING THIS PRODUCT. KEEP THE SAFETY AND OPERATING INSTRUCTIONS FOR FUTURE USE.

The warranty claim and guarantee is rendered invalid in the event of damage to the product, which is caused by not following the operating instructions. We are not liable for the consequent damage. Because of specific characteristics of LED's (life, deviation in colour etc.) we formulated special terms for planning and installing our LED products. They are part of these installation manual! Should they not be available, request them please!

SAFETY INFORMATION



- The light is suitable for lighting purpose indoors.
- The LED light is provided for load-bearing and suspended ceiling with ceiling cut-out according to data sheet. Sizes see technical data.
- Do not attach any additional loads such as decorations and / or signs to the luminaire!



- Don't install under power.
- Follow the instruction manual for installation.
- Installation only by qualified and authorised persons.
- Do not use the product when it has been damaged (defective covers) or there are operational faults such as flickering, smoking, steaming, crackling noises or the smell of smoke.
- A damaged or defective product must be changed or repaired by the manufacturer, a service person or a comparable qualified person.
- Installation only under observance of the valid guidelines specific to application and country among others VDE 0.100.
- Never open one of the electrical operating agents or plug any objects into them. Such procedures signify a danger to life through electrical shock.
- Absolutely avoid contact between the product and water or other liquids. For reasons of electrical safety, the light may not be placed in contact with water or other liquids or submerged in water.
- The product may not be changed or modified.
- In operation or after extended periods of operation, avoid touching the external surface of the LED luminaire, there is a danger of high temperatures that can cause burns.
- Don't look directly into the LED! The LED is that bright that it might damage your eyes!
- The luminaire must not be exposed to high levels of dust.



MAINTENANCE AND CLEANING

The light source is only exchangeable by a professional.



- Do not use solvents, such as benzene and similar agents. The light would be damaged thereby.
- Only use a dry, lint-free cloth for cleaning the product.

MAYA

LED wall luminaire swivelling

MAYAW-6SW1-1D MAYAW-6SW1-2D
MAYAW-6SW2-1D MAYAW-6SW2-2D
MAYAW-6SW24-1D MAYAW-6SW24-2D
MAYAW-6SW3-1D MAYAW-6SW3-2D

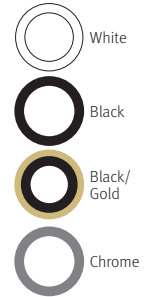

INTENDED USAGE

This product will only serve the purpose of illumination.

SCOPE OF DELIVERY

LED track light with adapter
Set of instructions for assembly, operation and safety

TECHNICAL CHANGES

Changes in the sense of technical progress can be made without prior notice.

address | contact

A.L.S. GmbH
Mastorter Str. 31 | 88069 Tettnang (Germany)
Tel.: +49 (0) 75 42 93 44-0 | Fax.: +49 (0) 75 42 93 44-30
E-Mail: info@als.de | Web: www.als.de

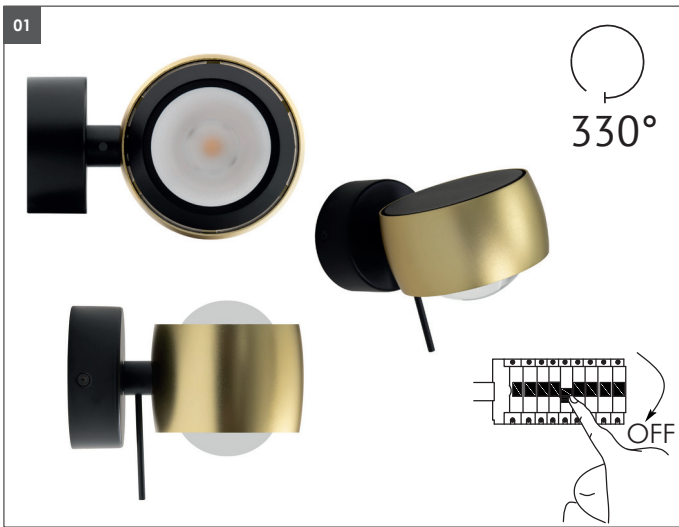

01 Schalten Sie vor der Montage und dem Anschluss die Netzspannung allpolig ab. Schalten Sie dazu den zugehörigen Sicherungsautomaten ab bzw. drehen Sie die Sicherung heraus. Schalten Sie außerdem den zugehörigen FI-Schutzschalter ab, so dass die Netzzuleitung allpolig von der Netzspannung getrennt ist. Sichern Sie diese vor versehentlichem Einschalten mit einem Warnschild o.ä. ab. Überprüfen Sie anschließend die Netzzuleitung zur Leuchte auf Spannungsfreiheit, verwenden Sie dazu ein geeignetes Messgerät (z.B. Digitalmultimeter).

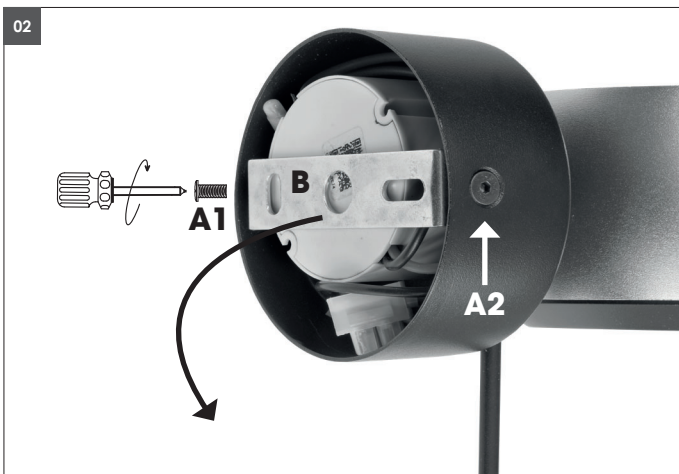

02 Loosen the 2 lateral screws (**A1+A2**) on the wall canopy and remove the mounting bracket (**B**).

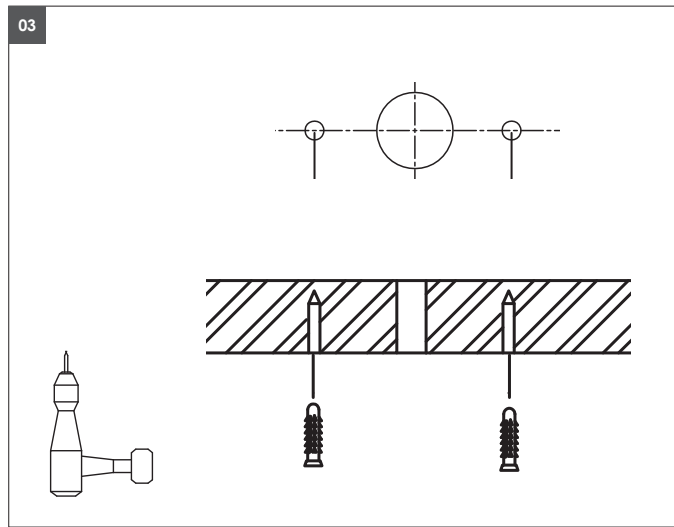

03 Transfer the drill holes to the wall with the mounting bracket.
Pay attention to underlying installations before drilling.

Another installation / assembly / materials / types than provided in the manual sheets, release us from any electrotechnical and electrostatic responsibility.

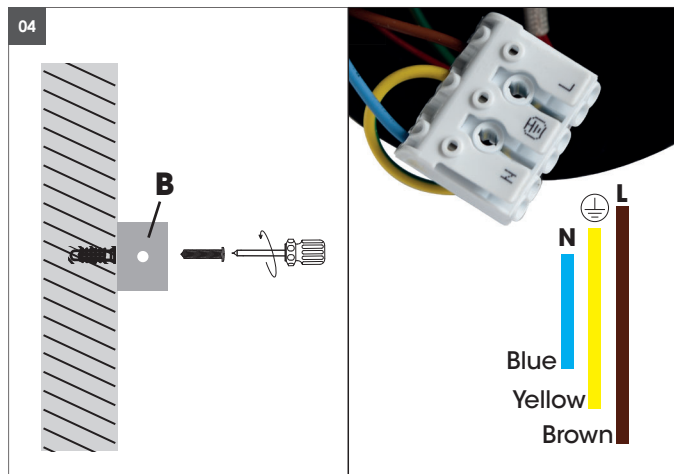

04 Fasten the mounting bracket (**B**) with suitable mounting material and then check it for tightness.

05 Connect the cables according to the VDE 0100 regulations and place the LED wall light flush to the wall on the mounting bracket.

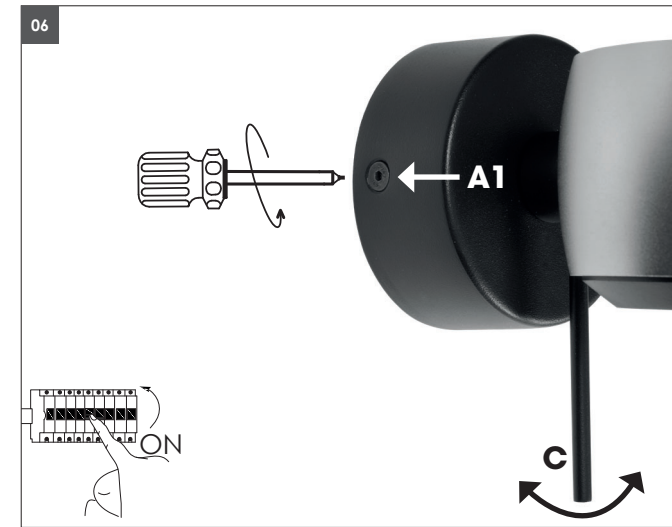

06 Fasten the wall canopy to the mounting bracket with two screws (**A1+A2**). After installation and connection, switch on the mains voltage at all poles.
Caution of the luminaire body is very warm after long operation.

To swivel, screw in the supplied rod and set the desired position of the luminaire (**C**).



Avoid looking too long in the light exit near the light, they could damage your eyes.

Fixing materials:

The warranty is void if the buyer or a third party repairs or modifies the luminaire.