

## DESCRIPTION OF PARTS

Gimbal LED recessed downlight  
 Body painted metal  
 Housing: black/ white and black/black  
 Incl. remote power supply









## TECHNICAL DATA

|                    |   |  |
|--------------------|---|--|
| Article number     | LOX-16NW 1-2<br>LOX-16WW1-2<br>LOX-16NW2<br>LOX-16WW2 | LOX-216NW1-2<br>LOX-216WW1-2<br>LOX-216NW2<br>LOX-216WW2 |
|                    | 220-240V , 50-60 Hz, not dimmable                     |  |
| Power consumption  | <b>15W</b>  | <b>30W</b>   |
| Dimensions (LxWxH) | 113x113x129 mm  | 223x113x129 mm   |
| Cutout             | 102x102 mm  | 212x102 mm   |

Protection class: II  
 Protection type: IP20  
 Installation: Ceiling recessed mounted  
 Light color: 3000K/4000K  
 Beam angle: 35°  
 30° swiveling LED modules  
 The LED light agent cannot be replaced.

## ACCESSORIES

**LOX-R35-16** PC chrome reflector, 35° for LOX-16

|  |  |   |   |
|--|--|---|---|
|    | Protection class II  |    | Notification of Risks   |
|    | CE label   |    | Safety Instructions   |
|   | The product is only for use in interiors.                    |   | Cleaning Instructions   |
|  | The product may not be disposed of in the household garbage. |  | It is not allowed to cover luminaires with heatinsulating cover sheet or similar materials! |
|  | LED luminaire is not dimmable                                |   |   |

## DISPOSAL

The packaging consists of environmentally friendly materials. Dispose of them in the local recycling containers.

 Do not dispose of this product in the household garbage when it has reached the end of its lifecycle, but rather take it to a disposal center. Your local officials will provide you with information about collection offices and their business hours.

## SAFETY



READ THE INSTRUCTIONS BEFORE USING THIS PRODUCT. KEEP THE SAFETY AND OPERATING INSTRUCTIONS FOR FUTURE USE.

The warranty claim and guarantee is rendered invalid in the event of damage to the product, which is caused by not following the operating instructions. We are not liable for the consequent damage. Because of specific characteristics of LED's (life, deviation in colour etc.) we formulated special terms for planing and installing our LED products. They are part of these installation manual! Should they not be available, request them please! Don't look directly into the LED! The LED is that bright that it might damage your eyes!

## SAFETY INFORMATION



- The light is suitable for lighting purpose indoors.
- The LED light is provided for load-bearing and suspended ceiling with ceiling cut-out according to data sheet. Sizes see technical data.
- Please consider the minimum insertion depth, space of additional 30 mm must be respected around (see technical data).



- Don't install under power.
- Follow the instruction manual for installation.
- Installation only by qualified and authorised persons.
- Do not use the product when it has been damaged (defective covers) or there are operational faults such as flickering, smoking, steaming, crackling noises or the smell of smoke.
- A damaged or defective product must be changed or repaired by the manufacturer, a service person or a comparable qualified person.
- Installation only under observance of the valid guidelines specific to application and country among others VDE 0.100.
- Never open one of the electrical operating agents or plug any objects into them. Such procedures signify a danger to life through electrical shock.
- Absolutely avoid contact between the product and water or other liquids. For reasons of electrical safety, the light may not be placed in contact with water or other liquids or submerged in water.
- The product may not be changed or modified.

## MAINTENANCE AND CLEANING

The LED light agent cannot be replaced.



- Do not use solvents, such as benzene and similar agents. The light would be damaged thereby.
- Only use a dry, lint-free cloth for cleaning the product.

**LOX**

Gimbal LED recessed downlight

LOX-16NW1-2 / LOX-16NW2    LOX-216NW1-2 / LOX-216NW2  
 LOX-16WW1-2 / LOX-16WW2    LOX-216WW1-2 / LOX-216WW2

**ALS**  
 ARCHITEKTONISCHE  
 L I C H T  
 S Y S T E M E

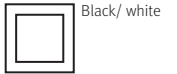
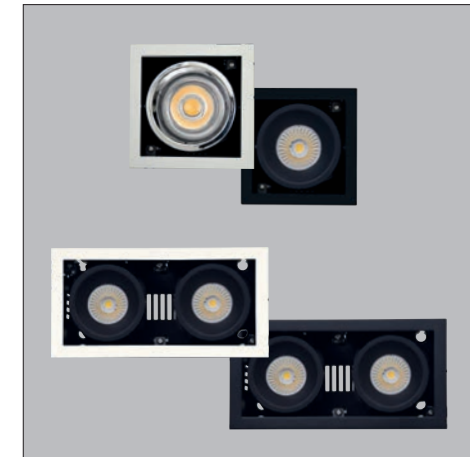

## INTENDED USAGE

This product will only serve the purpose of illumination.

## SCOPE OF DELIVERY

LED light  
 Philips LED driver  
 Set of instructions for assembly, operation and safety

address | contact

A.L.S. GmbH  
 Mastorter Str. 29 | 88069 Tettnang (Germany)  
 Tel.: +49 (0) 75 42 93 44-0 | Fax.: +49 (0) 75 42 93 44-30  
 E-Mail: info@als.de | Web: www.als.de

Version: 2018-05-26

**EN**

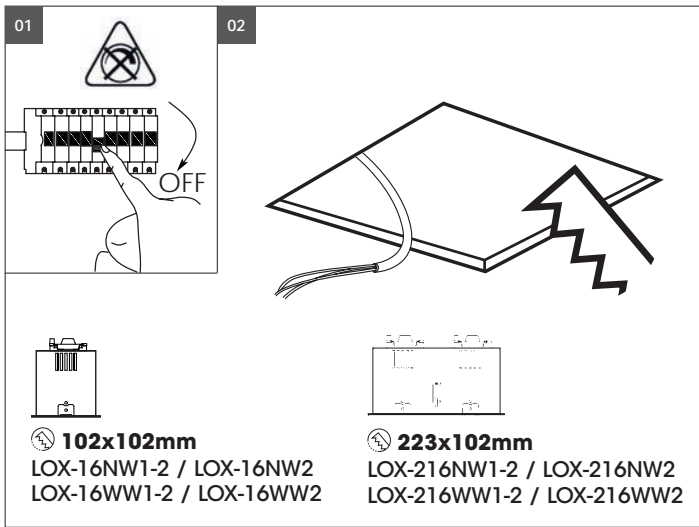

**01** Switch off before installation. Switch on only after complete installation and examination of the circuit. Professional electrician for installation and maintenance only. Turn Off power supply before starting any installation. Read instructions & check you have all the tools & accessories to complete the installation correctly. Open a hole according to the cutout size of led downlight.

**02** Prepare the ceiling cut-out according to the size of the luminaire (see technical data).

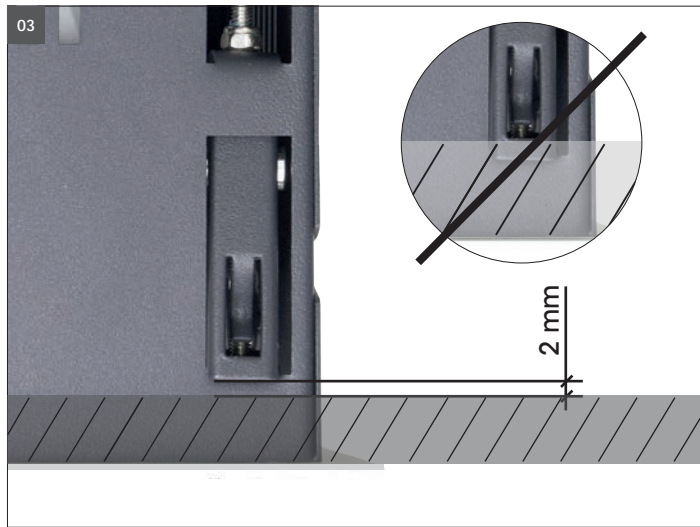

**03** The thickness of the ceiling material is to be considered! The distance to the clamps must be 2 mm.

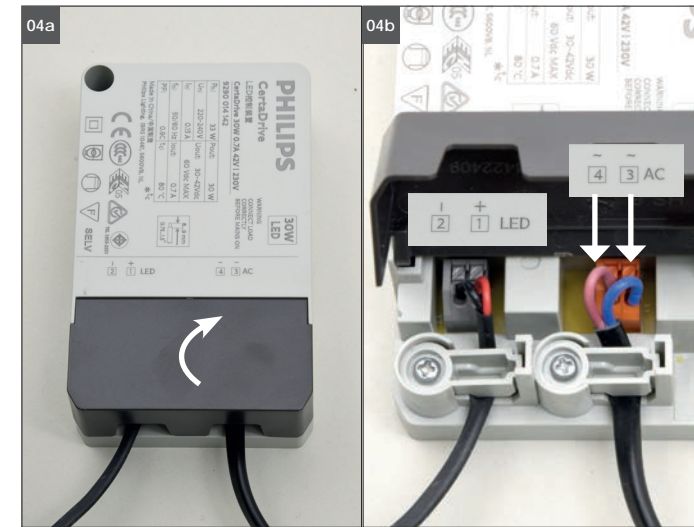

**04a** Open the driver cover.

**04b** Feed the main AC wire to the fast connection terminal block respectively. Attach strain relief and fix the cover back.

**Fixing materials:**

The warranty is void if the buyer or a third party repairs or modifies the luminaire.



**05** Insert the luminaire together with the LED converter into the prepared opening until the edge rests flush against the ceiling. It is important to ensure sufficient distance between the LED lamp and the plants, ceilings, heating pipes, etc. installed behind it. In order to avoid accumulated heat, the necessary installation depth must be observed (additional 30 mm on all sides, see technical data).

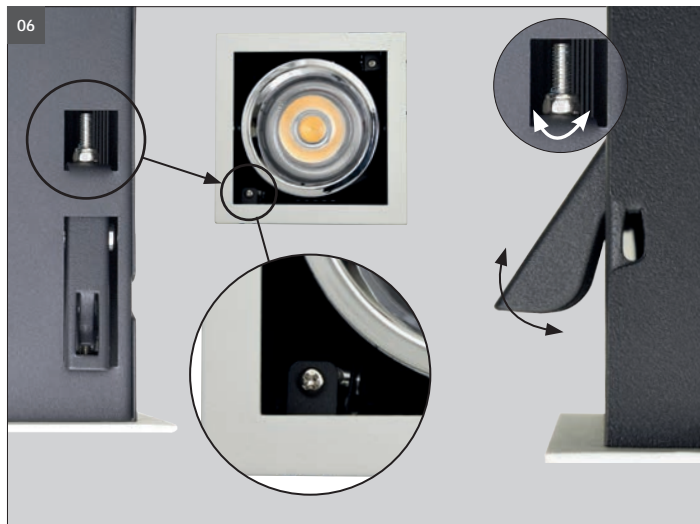

**It is not allowed to cover luminaires and LED driver with heatinsulating cover sheet or similar materials! Additional drillings in the LED luminaire are not allowed!**

**06** Fixation by adjusting screws. To ensure safe installation, the clamps must rest firmly and flush on the material. Check the luminaire for tightness after installation.



Turn on the power.

Another installation / assembly / materials / types than provided in the manual sheets, release us from any electrotechnical and electrostatic responsibility.