

DESCRIPTION OF PARTS

LED Downlight with single reflectors.
housing: white
Integrated LED driver dimmable.

TECHNICAL DATA

Power supply: 220 - 240 V / AC, 50 Hz
Wattage: max. approx. 10W / 18W / 25W
Energy efficiency class: A
Energy consumption 1000 h: 10 / 18 / 25 kWh
Protection class: I
Protection type: IP54 frontal
Installation: Ceiling recessed mounted
Light color: 4000K
Lifespan of LEDs approx.: > 30000 h
Ambient temperature: -20 °C bis +60 °C
Beam angle: 90°
CRI: >80
Dimensions:
Ø 10W = 110mm / 18W = 190 mm / 25W = 228 mm, height 37 mm
Ceiling Opening: 10W = 95 mm / 18W = 165 mm / 25W = 205 mm

The LED light agent cannot be replaced.



Protection class I



Notification of Risks



CE label



Safety Instructions



Splashing water
IP54 frontal



Cleaning Instructions



The product may not
be disposed of in the
household garbage.



It is not allowed to
cover luminaires
with heatinsulating
cover sheet or similar
materials!



Triac dimmable

SAFETY



READ THE INSTRUCTIONS BEFORE USING THIS PRODUCT.
KEEP THE SAFETY AND OPERATING INSTRUCTIONS FOR
FUTURE USE.

The warranty claim and guarantee is rendered invalid in the event of damage to the product, which is caused by not following the operating instructions. We are not liable for the consequent damage. Because of specific characteristics of LED's (life, deviation in colour etc.) we formulated special terms for planing and installing our LED products. They are part of these installation manual! Should they not be available, request them please! Don't look directly into the LED! The LED is that bright that it might damage your eyes!

SAFETY INFORMATION



- The light is suitable for lighting purpose indoors and outdoors.
- The LED light is provided for load-bearing and suspended ceiling with ceiling cut-out according to data sheet. Sizes see technical data.
- Please consider the minimum insertion depth, space of additional 30 mm must be respected around (see technical data). IP54 frontal.



- Don't install under power.
- Follow the instruction manual for installation.
- Installation only by qualified and authorised persons.
- Do not use the product when it has been damaged (defective covers) or there are operational faults such as flickering, smoking, steaming, crackling noises or the smell of smoke.
- A damaged or defective product must be changed or repaired by the manufacturer, a service person or a comparable qualified person.
- Installation only under observance of the valid guidelines specific to application and country among others VDE 0.100.
- Never open one of the electrical operating agents or plug any objects into them. Such procedures signify a danger to life through electrical shock.
- Absolutely avoid contact between the product and water or other liquids. For reasons of electrical safety, the light may not be placed in contact with water or other liquids or submerged in water.
- The product may not be changed or modified.

MAINTENANCE AND CLEANING

The LED light agent cannot be replaced.



- Do not use solvents, such as benzene and similar agents. The light would be damaged thereby.
- Only use a dry, lint-free cloth for cleaning the product.

EVA

LED Downlight

EVA-10NW1D/EVA-10WW1D
EVA-18NW1D/EVA-18WW1D
EVA-25NW1D/EVA-25WW1D

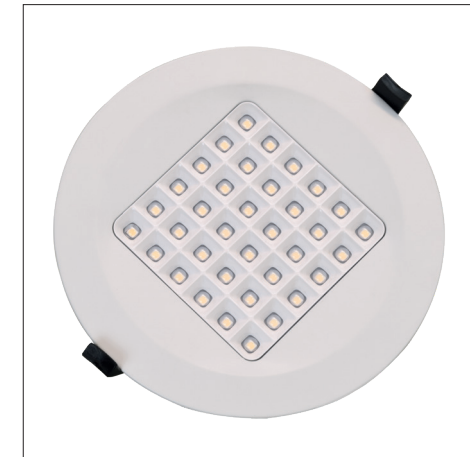

White



INTENDED USAGE

This product will only serve the purpose of illumination.

SCOPE OF DELIVERY

1 x LED light
1 x set of instructions for assembly, operation and safety

DISPOSAL

The packaging consists of environmentally friendly materials.
Dispose of them in the local recycling containers.



Do not dispose of this product in the household garbage when it has reached the end of its lifecycle, but rather take it to a disposal center. Your local officials will provide you with information about collection offices and their business hours.

address | contact

A.L.S. GmbH & Co. KG
Mastorter Str. 29 | 88069 Tettnang (Germany)
Tel.: +49 (0) 75 42 93 44-0 | Fax.: +49 (0) 75 42 93 44-30
E-Mail: info@als.de | Web: www.als.de

01

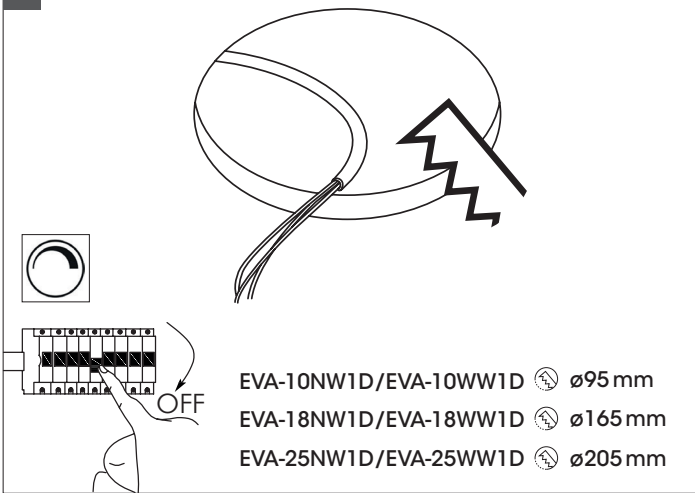

Switch off before installation. Switch on only after complete installation and examination of the circuit. Professional electrician for installation and maintenance only. Turn Off power supply before starting any installation. Read instructions & check you have all the tools & accessories to complete the installation correctly. Open a hole according to the cutout size of led downlight.

02a



EVA-10

02b

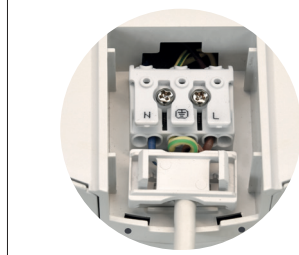
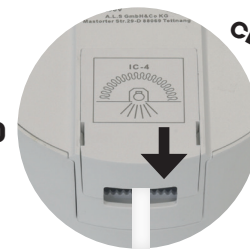
EVA-18
EVA-25

Open the driver cover. Feed the main AC wire L ⊕ N to the fast connection terminal block respectively. Fix the cover back.

The terminal connection is not suitable for through-wiring. The cable relief is only designed for one cable!

Fixing materials: cable relief, clamps

The warranty is void if the buyer or a third party repairs or modifies the luminaire.

03a

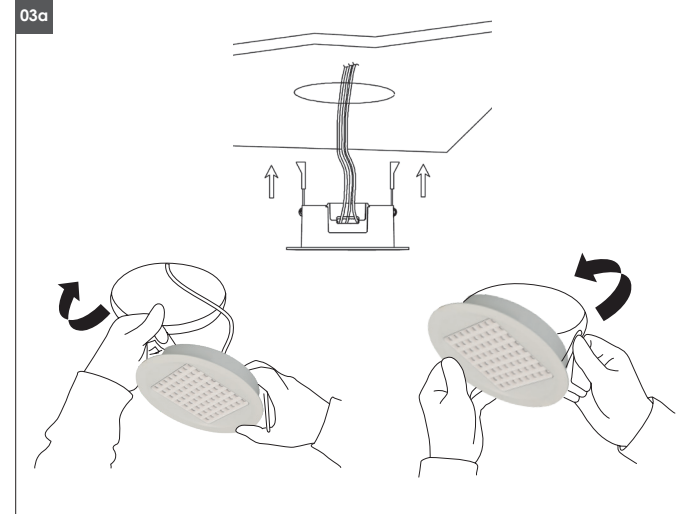

Hold back spring clips then push downlight into the hole. Make sure the downlight fixed tightly in ceiling.

03b

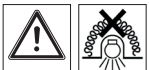
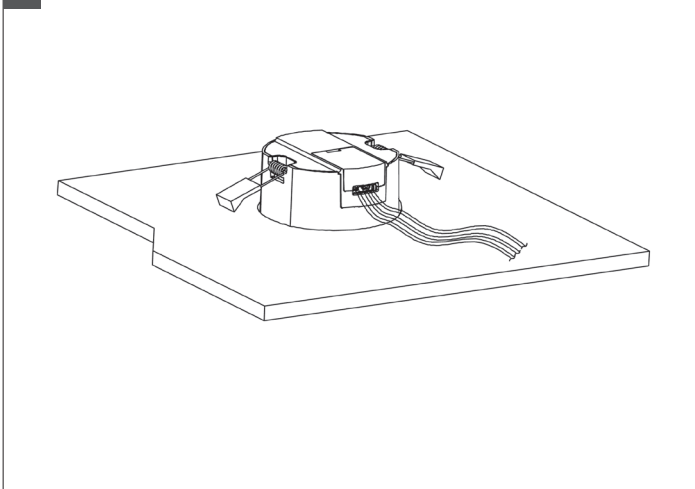

It is not allowed to cover luminaires with heatinsulating cover sheet or similar materials!
 Additional drillings in the LED luminaire are not allowed!

03c

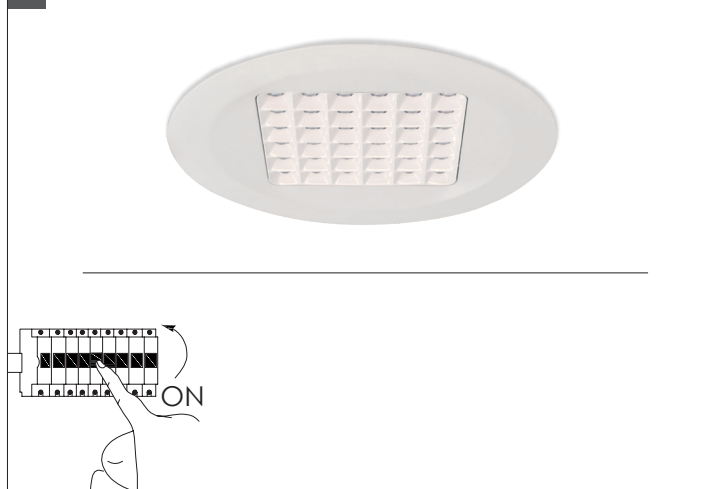

Turn on the power.

Another installation / assembly / materials / types than provided in the manual sheets, release us from any electrotechnical and electrostatic responsibility.