

DESCRIPTION OF PARTS

DDH4 LED panel recessed ceiling luminaire, 40W, Modul,
Diffuser prismatic, Mitsubishi prismatic cover with PMMA reflector
Frame colour: White
Optional mounting frame:
Order number: ELEDN-AUR120

TECHNICAL DATA

LED incl. driver
220-240V ~ 50/60 Hz
Total power consumption: 40W
Not dimmable (on request)

IP class 20
Protection class: II
Flickerfree

DDH4-40NW1 1P, light colour: 4000K
Light source: A.L.S. GmbH - EP830932-1-40NW1

DDH4-40WW1 1P, light colour: 3000K
Light source: A.L.S. GmbH - EP830932-1-40WW1

This luminaire contains two light sources of energy efficiency class E
The product consists of two components. Luminaire with light source and
external LED Driver.

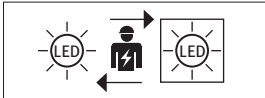

The light source is only exchange-
able by a professional.

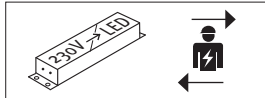

The LED driver is only exchangeable
by a professional.

Dimensions:
L1200xW300xH9mm

LAMP

LED

LED DRIVER

nominal voltage,
primary: 220-240V ~ (50/60 Hz)
Pout 40W iout 950mA



Protection class II



Notification of Risks



CE label



Safety Instructions



The product is only
for use in interiors.



Cleaning Instructions



The product may not
be disposed of in the
household garbage.



It is not allowed to
cover luminaires
with heatinsulating
cover sheet or similar
materials!



Not dimmable
(on request)



Not recommended
for children under 3
years

SAFETY



READ THE INSTRUCTIONS BEFORE USING THIS PRODUCT.
KEEP THE SAFETY AND OPERATING INSTRUCTIONS FOR
FUTURE USE.

SAFETY INFORMATION



- The light is only suitable for use in interiors, in dry, enclosed rooms.
- The light is not suitable for attaching on uneven surface. The light may otherwise fall. This can result in product damage and / or injuries.



- Don't install under power.
- Follow the instruction manual for installation.
- Installation only by qualified and authorised persons.
- Do not leave packaging material lying around carelessly, there is a risk of suffocation.
- Do not use the product when it has been damaged (defective covers) or there are operational faults such as flickering, smoking, steaming, crackling noises or the smell of smoke.
- A damaged or defective product must be changed or repaired by the manufacturer, a service person or a comparable qualified person.
- Installation only under observance of the valid guidelines specific to application and country among others VDE 0.100.
- Never open one of the electrical operating agents or plug any objects into them. Such procedures signify a danger to life through electrical shock.
- Absolutely avoid contact between the product and water or other liquids. For reasons of electrical safety, the light may not be placed in contact with water or other liquids or submerged in water.
- The product may not be changed or modified.



MAINTENANCE AND CLEANING

The LED driver is only exchangeable by a professional.



- Do not use solvents, such as benzene and similar agents. The light would be damaged thereby.
- Only use a dry, lint-free cloth for cleaning the product.

DISPOSAL

The packaging consists of environmentally friendly materials.
Dispose of them in the local recycling containers.



Do not dispose of this product in the household garbage when it has reached the end of its lifecycle, but rather take it to a disposal center. Your local officials will provide you with information about collection offices and their business hours.

DDH4

Mounted luminaire/Recessed ceiling luminaire

DDH4-40NW1 1P
DDH4-40WW1 1P



White



INTENDED USAGE

This product will only serve the purpose of illumination.

The light is only suitable for use in interiors, in dry, enclosed rooms.

SCOPE OF DELIVERY

1 x LED panel recessed ceiling luminaire
1 x Ballast Xitanium 44W G3 0.9-1.05A 42V (TRL-44W1050)
1 x set of instructions for assembly, operation and safety

address | contact

A.L.S. GmbH
Mastorter Str. 31 | 88069 Tettnang (Germany)
Tel.: +49 (0) 75 42 93 44-0 | Fax.: +49 (0) 75 42 93 44-30
E-Mail: info@als.de | Web: www.als.de

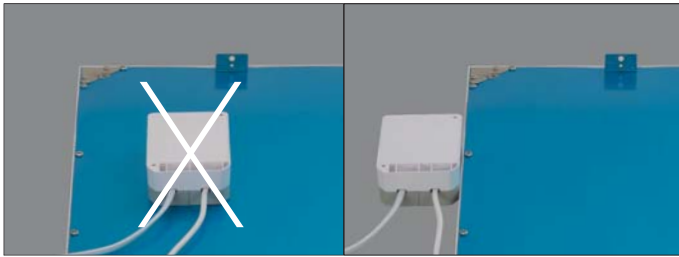
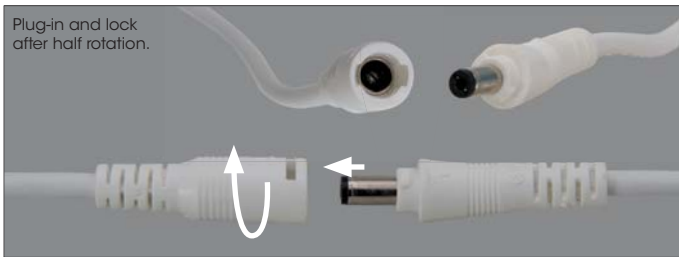

In case of ceiling installation place LED converter sideways to the light.



Please check that the lamp has an electronic ballast with connection for functional earth. If so, please connect the functional earth according to the valid standards and guidelines!

Assembly instructions for LED panel

Carefully remove the LED panel from its packaging. Over the corner edge of the light carefully put it into the ceiling section. Avoid mechanical tensions on panel, the light should have some space.



Turn Off power supply before starting any installation. Do not connect the device under power. Connect the supply cables according to the electrical regulations to the primary connection 230V AC to LED converter.

The electrical connection from LED panel to the converter is connected with a plug-in connector. Do not unplug before switching on, also not during operating the lamp.

Only use the supplied LED converter! Other converters or transformers may destroy the light.

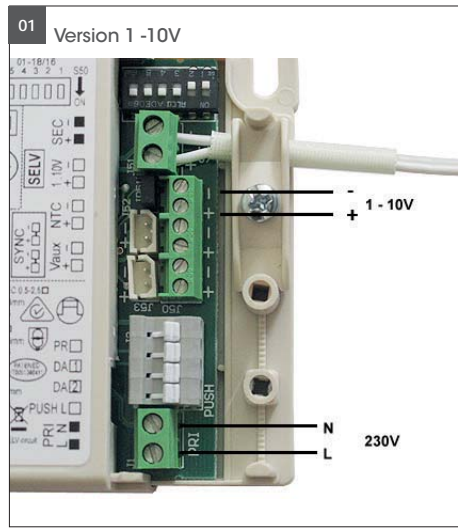

01. Connect the LED power supply to main power and connect the LED power supply with the light, see Fig. 01. Connect the wires at the power supply on primary an secondary side. Max. conductor cross-section 1,5 mm².

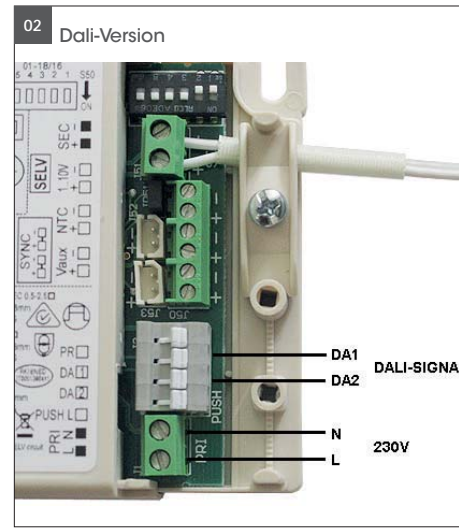

02. Connect the LED power supply to main power and connect the LED power supply with the light, see Fig. 02. Connect the wires at the power supply on primary an secondary side. conductor cross-section 1,5 mm².

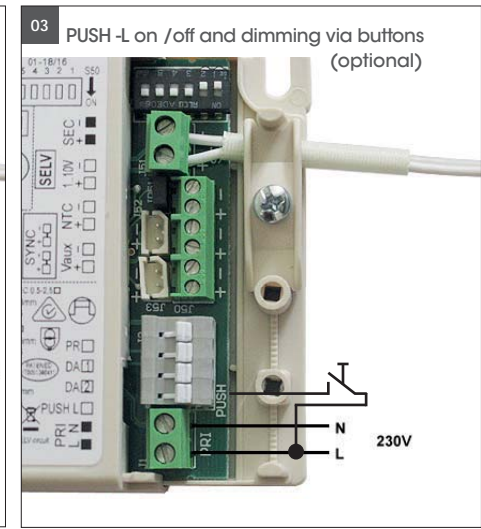

03. Connect the connection cables to the power supply, see Fig. 03. Then connect the power supply to the luminaire and connect the power supply unit to the power supply max., conductor cross section 1.5mm². For the PUSH -L dimming input always use the phase that also powers the power supply!



It is not allowed to cover LED panel and LED converter with heatinsulating cover sheet or similar materials! Additional drillings in the LED luminaire are not allowed! Do not place the LED converter on the LED pendant luminaire to avoid unnecessary transfer of heat.

Another installation / assembly / materials / types than provided in the manual sheets, release us from any electrotechnical and electrostatic responsibility.

Fixing materials:

Pendant mounting order number Z-ELEDN
Assembly frame order number ELED4-AUR
The warranty is void if the buyer or a third party repairs or modifies the luminaire.

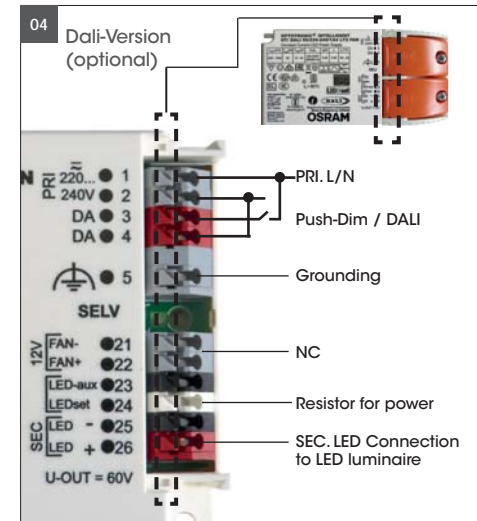

04. Connect the LED power supply to main power and connect the LED power supply with the light, see Fig. 02a. Connect the wires at the power supply on primary an secondary side. conductor cross-section 1,5 mm²



Only use the supplied LED converter! Other converters or transformers may destroy the light. The DIP setting must not be changed!