



Description

STAMP Wandanbauleuchte LED 10W, CRI 80, IP65, 4000K 230V, IK10, 60.000 h Lebensdauer, inkl. Treiber, UV stabilisierte Lackierung, anthrazit

General data

Colour housing:	Anthracite
Degree of protection (IP):	IP65
Material housing:	Aluminium
Protection class:	I
Suitable for built-in mounting:	Yes
Suitable for surface mounting:	Yes
Suitable for wall mounting:	Yes

Photometric data

:	F
Colour of light:	White
Colour rendering index CRI:	80-89
Colour temperature:	4000K
Light outlet:	Direct
Light sharing:	Asymmetric
Max. system power:	10W
Rated life time L70/B50 at 25 °C:	50000h

Electrical data

Exchangeable control gear:	Yes
Impact strength:	IK10
No dim function:	Yes
Nominal voltage:	230V
Voltage type:	AC

Product dimensions

Height/depth:	30mm
Length:	175mm

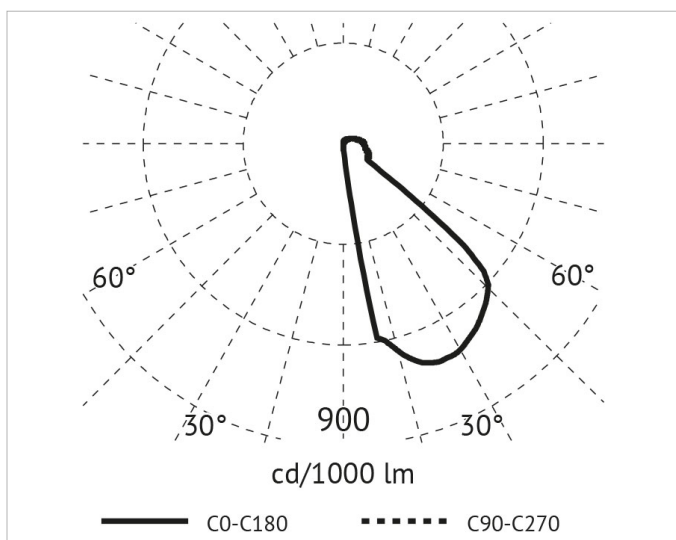
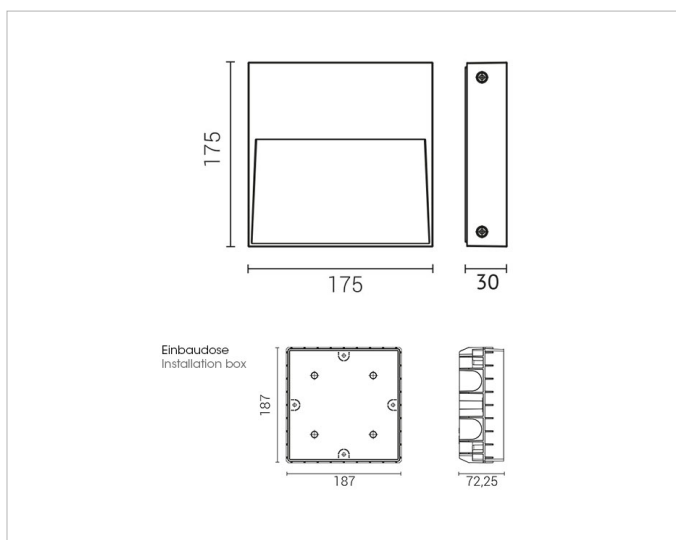

Address/Contact



Width:

175mm

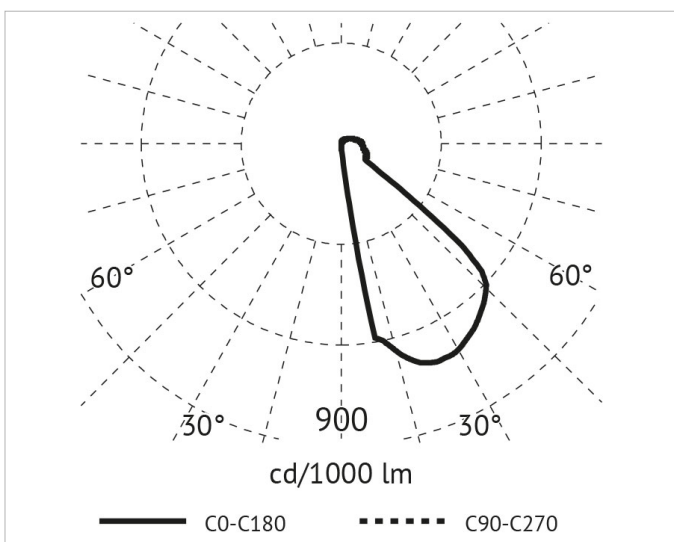
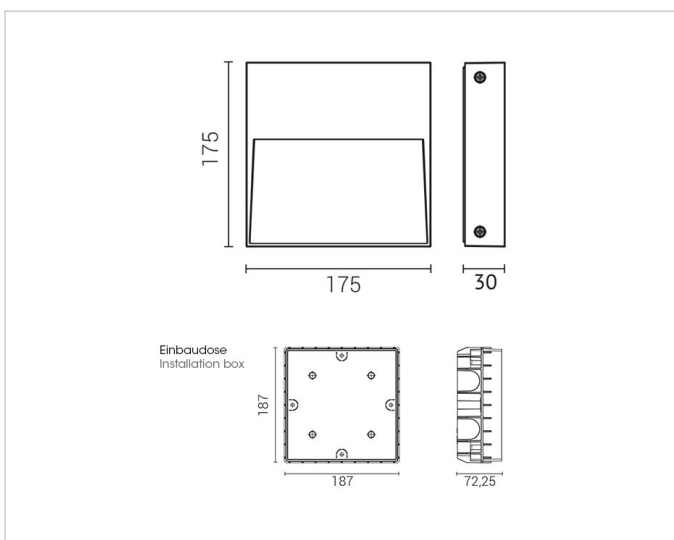

Adress/Contact