



Beschreibung

3-Phasen-Stromschiene, für Einbau 3m, schwarz

Allgemeine Daten

Geeignet für Einbaumontage:	Ja
Schutzklasse:	I
Werkstoff:	Aluminium

Elektrische Daten

Nennspannung:	230V
----------------------	------

Produktabmessung

Breite:	59mm
Länge:	3000mm

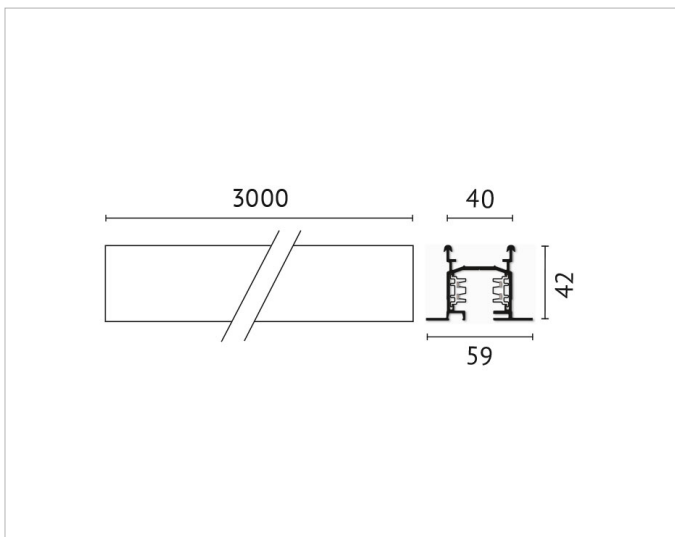

Adresse/Kontakt